

ATF 90G-4

90 METRISCHE TONNEN TRAGLAST / 90 METRIC TON CAPACITY

**ALL
TERRAIN
CRANE**



Maße (mm)
 Dimensions (mm)
 Dimensiones (mm)

 445/95 R 25
 (16.00 R 25)

DIN/ISO/EN

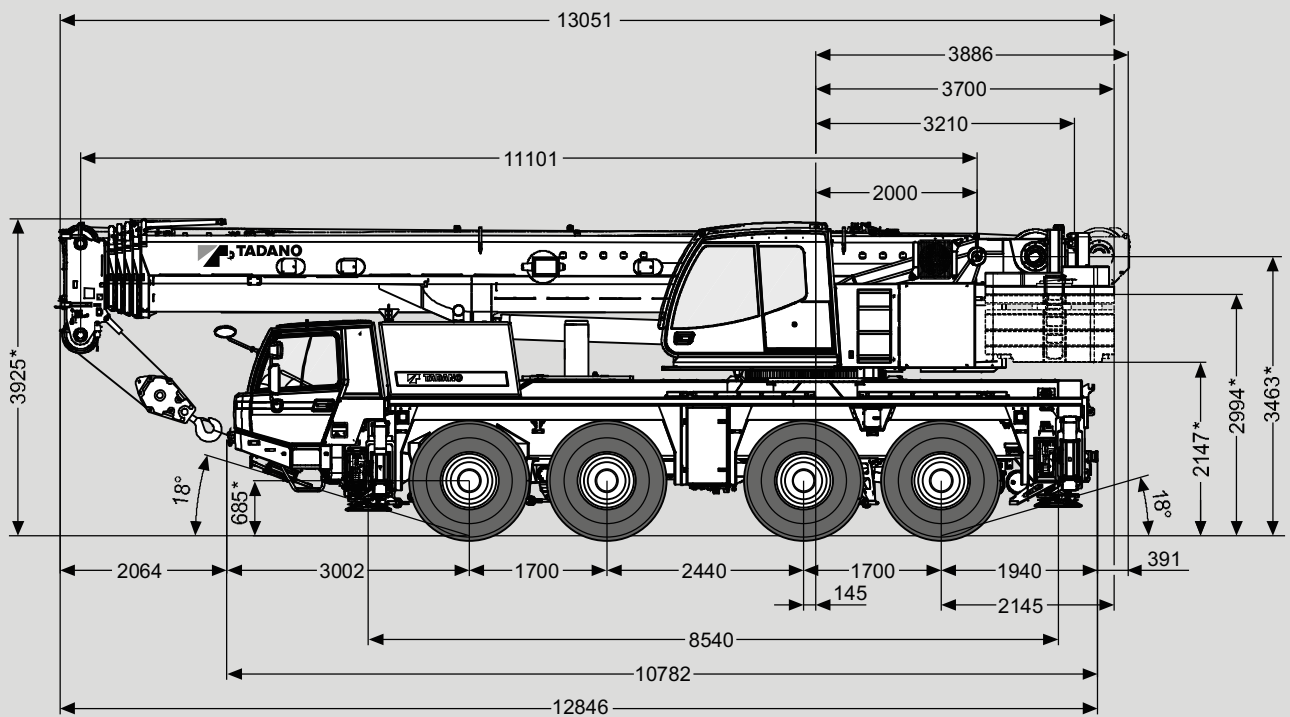

* ± 100

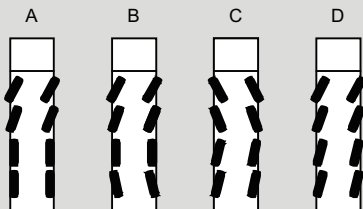
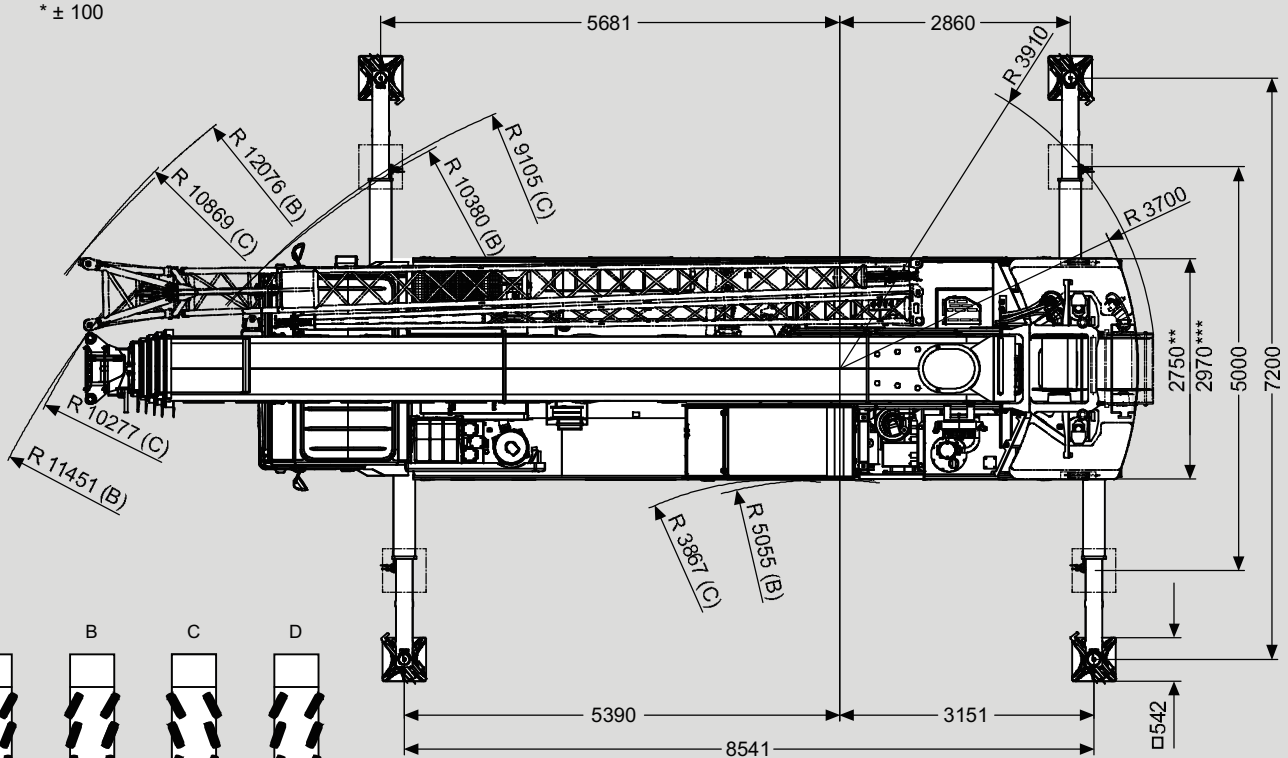

v > 25 km/h v < 25 km/h

** 385/95 R 25 (14.00 R25), 445/95 R 25 (16.00 R25)
 *** 525/80 R 25 (20.5 R25)

Gewichte / Geschwindigkeiten
Weights / Working speeds
Poids / Vitesses
Pesos / Velocidades de trabajo

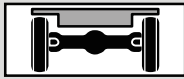
	Achse / Axle Essieu / Eje	1	2	3	4	Gesamtgewicht / Total weight Poids total / Peso total
	(t)	12	12	12	12	48*

* Incl. 6,5 t Gegengewicht, 10 / 18 m Auslegerverlängerung, Unterflasche, Hakengeschirr, Bereifung 445/95 R 25 (16.00 R 25).

* Incl. 6.5 t counterweight, 10 / 18 m boom extension, hook block, swivel hook, tyres 445/95 R 25 (16.00 R 25).

* Incl. de 6,5 t contrepoids, 10 m / 18 m flèche, moufle, élingues, pneus 445/95 R 25 (16.00 R 25).

* Incl. contrapeso de 6,5 t, 10 m / 18 m plumin, gancho, gancho de bola, neumáticos 445/95 R 25 (16.00 R 25).

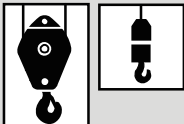
	Traglast / Lifting capacity / Force de levage / Capacidad de elevación	Rollen / Sheaves Pulies / Poleas	Stränge / Parts of line Brins / Ramales de cable	Gewicht / Weight Poid / Peso
	59.1 t (Typ / Type / Typo 63)*	5	11	650 kg
	38.1 t (Typ / Type / Typo 40)*	3	7	550 kg
	38.1 t (Typ / Type / Typo 40)	3	7	550 kg
	16.5 t (Typ / Type / Typo 20)	1	3	300 kg
	5.6 t (Typ / Type / Typo 6)	–	1	150 kg







* Doppelhaken







* Rams horn

* Moufle avec crochet marin

* Gancho doble

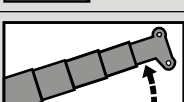

	1	2	3	4	5	6	7	8	9	10	11	12	R1	R2	
	3	4	5	7	9	11	15	19	24	31	40	51	4	5	
	6	7	9	12	15	19	26	33	42	54	69	85	6	8	62%
	4	5	6	8	10	12	16	21	27	34	43	56	4	5	
	6	8	10	13	16	21	28	36	46	59	75	85	7	8	
															

V+ 	Stufenlos Infinitely variable Progressivement variable Infinitamente variable	Seil Rope Câble Cable	Max. Seilzug Max. single line pull Effort maxi au brin simple Trio máximo por ramal
	0 - 115 m/min für einfachen Strang single line au brin simple ramal simple	18 mm / 230 m	55 kN
	0 - 115 m/min für einfachen Strang single line au brin simple ramal simple	18 mm / 230 m	55 kN
	0 - 2 min ⁻¹		
	- 1° – + 82.4° ca. 35 s approx. 35 s env. 35 s aproximadamente 35 s		
	11.1 m – 51.2 m ca. 310 s approx. 310 s env. 310 s aproximadamente 310 s		

Hubhöhen
Lifting heights
Hauteurs de levage
Alturas de elevación

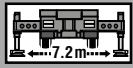
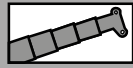

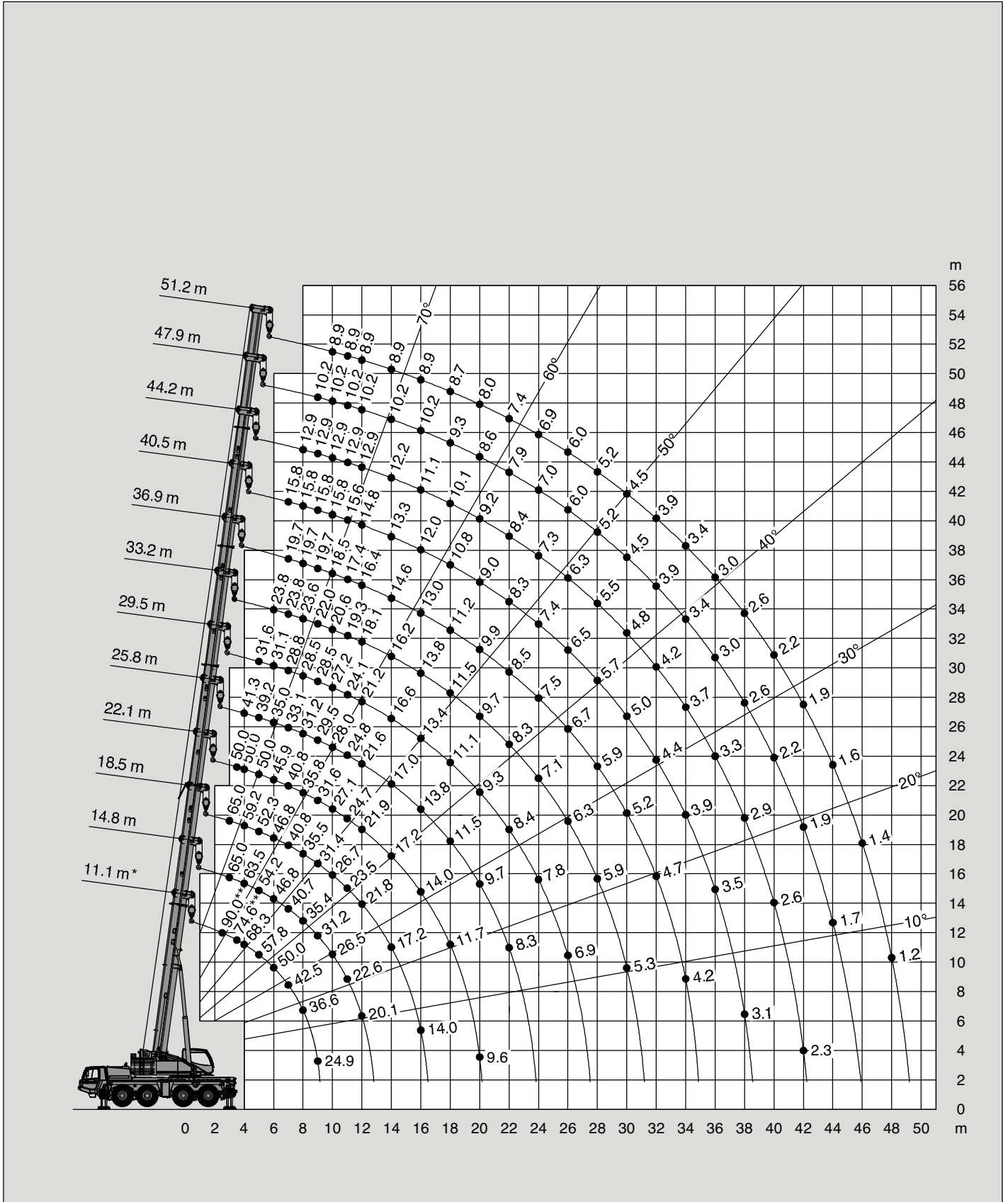

22.3t

DIN/ISO/EN

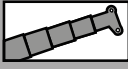
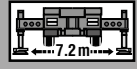

Tragfähigkeiten
Lifting capacities
Capacités de levage
Capacidades de elevación

    DIN/ISO/EN													
→ m	11.1 m*	11.1 m	14.8 m	18.5 m	22.1 m	25.8 m	29.5 m	33.2 m	36.9 m	40.5 m	44.2 m	47.9 m	51.2 m
2.5	90.0**												
3.0	81.6**	76.1**	65.0	65.0									
3.5	74.6**	70.1	65.0	63.2	50.0								
4.0	68.3	64.2	63.5	59.2	50.0	41.3							
4.5	62.6	59.1	58.7	55.6	50.0	40.9							
5.0	57.8	54.6	54.2	52.3	50.0	39.2	31.6						
6.0	50.0	47.3	46.8	46.8	45.9	35.0	31.1	23.8					
7.0	42.5	41.2	40.7	40.8	40.8	33.1	28.8	23.8	19.7	15.8			
8.0	36.6	35.4	35.4	35.5	35.8	31.2	28.5	23.6	19.7	15.8	12.9		
9.0	24.9	24.0	31.2	31.4	31.6	29.5	28.5	22.0	19.7	15.8	12.9	10.2	
10.0			26.5	26.7	27.1	28.0	27.2	20.6	18.5	15.8	12.9	10.2	8.9
11.0			22.6	23.5	24.7	24.8	24.1	19.3	17.4	15.6	12.9	10.2	8.9
12.0			20.1	21.8	21.9	21.6	21.2	18.1	16.4	14.8	12.9	10.2	8.9
14.0				17.2	17.2	17.0	16.6	16.2	14.6	13.3	12.2	10.2	8.9
16.0				14.0	14.0	13.8	13.4	13.8	13.0	12.0	11.1	10.2	8.9
18.0					11.7	11.5	11.1	11.5	11.2	10.8	10.1	9.3	8.7
20.0					9.6	9.7	9.3	9.7	9.9	9.0	9.2	8.6	8.0
22.0						8.3	8.4	8.3	8.5	8.3	8.4	7.9	7.4
24.0							7.8	7.1	7.5	7.4	7.3	7.0	6.9
26.0								6.9	6.3	6.7	6.5	6.0	6.0
28.0									5.9	5.9	5.7	5.5	5.2
30.0									5.3	5.2	5.0	4.8	4.5
32.0										4.7	4.4	4.2	3.9
34.0										4.2	3.9	3.7	3.4
36.0											3.5	3.3	3.0
38.0											3.1	2.9	2.6
40.0												2.6	2.2
42.0												2.3	1.9
44.0													1.7
46.0													1.4
48.0													1.2

* Nach hinten / * Over rear / * A l'arrière / * Sobre la parte trasera

** Mit Zusatzhubausrüstung / ** With additional lifting equipment / ** Avec équipement supplémentaire / ** Con equipo adicional

Hubhöhen
Lifting heights
Hauteurs de levage
Alturas de elevación

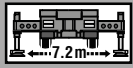
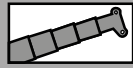

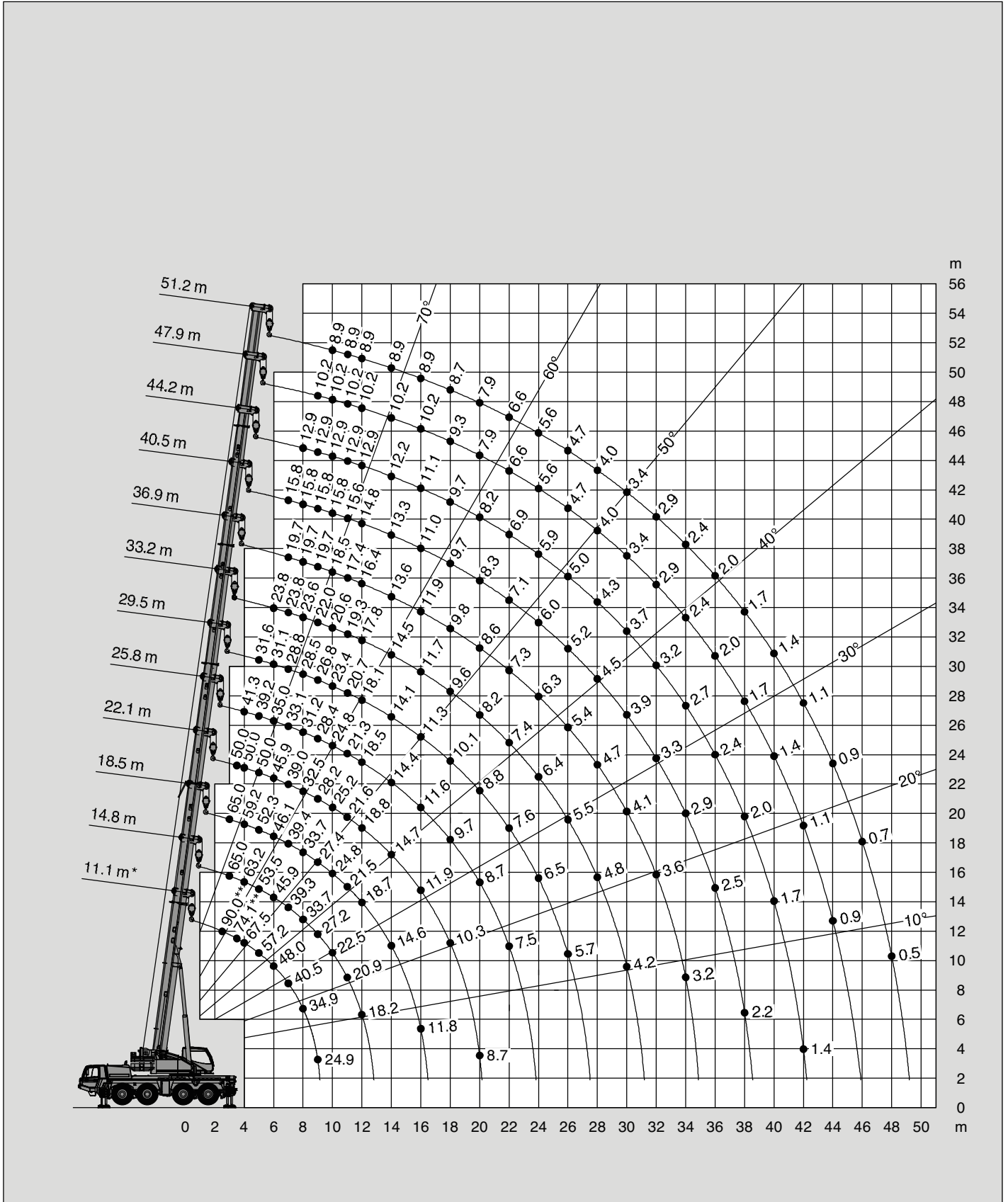

16.5t

DIN/ISO/EN

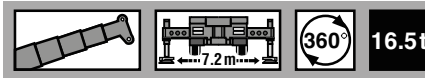

Tragfähigkeiten
Lifting capacities
Capacités de levage
Capacidades de elevación

 DIN/ISO/EN													
 m	11.1 m*	11.1 m	14.8 m	18.5 m	22.1 m	25.8 m	29.5 m	33.2 m	36.9 m	40.5 m	44.2 m	47.9 m	51.2 m
2.5	90.0**												
3.0	81.6**	76.5**	65.0	65.0									
3.5	74.1**	69.6	65.0	63.2	50.0								
4.0	67.5	63.7	63.2	59.2	50.0	41.3							
4.5	61.9	58.5	58.0	55.6	50.0	40.9							
5.0	57.2	54.0	53.5	52.3	50.0	39.2	31.6						
6.0	48.0	46.5	45.9	46.1	45.9	35.0	31.1	23.8					
7.0	40.5	39.8	39.3	39.4	39.0	33.1	28.8	23.8	19.7	15.8			
8.0	34.9	34.7	33.7	33.7	32.5	31.2	28.5	23.6	19.7	15.8	12.9		
9.0	24.9	24.0	27.2	27.4	28.2	28.4	26.8	22.0	19.7	15.8	12.9	10.2	
10.0			22.5	24.8	25.2	24.8	23.4	20.6	18.5	15.8	12.9	10.2	8.9
11.0			20.9	21.5	21.6	21.3	20.7	19.3	17.4	15.6	12.9	10.2	8.9
12.0			18.2	18.7	18.8	18.5	18.1	17.8	16.4	14.8	12.9	10.2	8.9
14.0				14.6	14.7	14.4	14.1	14.5	13.6	13.3	12.2	10.2	8.9
16.0				11.8	11.9	11.6	11.3	11.7	11.9	11.0	11.1	10.2	8.9
18.0					10.3	9.7	10.1	9.6	9.8	9.7	9.7	9.3	8.7
20.0					8.7	8.7	8.8	8.2	8.6	8.3	8.2	7.9	7.9
22.0						7.5	7.6	7.4	7.3	7.1	6.9	6.6	6.6
24.0							6.5	6.4	6.3	6.0	5.9	5.6	5.6
26.0							5.7	5.5	5.4	5.2	5.0	4.7	4.7
28.0								4.8	4.7	4.5	4.3	4.0	4.0
30.0								4.2	4.1	3.9	3.7	3.4	3.4
32.0									3.6	3.3	3.2	2.9	2.9
34.0									3.2	2.9	2.7	2.4	2.4
36.0										2.5	2.4	2.0	2.0
38.0										2.2	2.0	1.7	1.7
40.0											1.7	1.4	1.4
42.0											1.4	1.1	1.1
44.0												0.9	0.9
46.0													0.7
48.0													0.5

* Nach hinten / * Over rear / * A l'arrière / * Sobre la parte trasera

** Mit Zusatzhubausrüstung / ** With additional lifting equipment / ** Avec équipement supplémentaire / ** Con equipo adicional

Hubhöhen
Lifting heights
Hauteurs de levage
Alturas de elevación

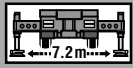
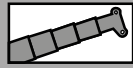

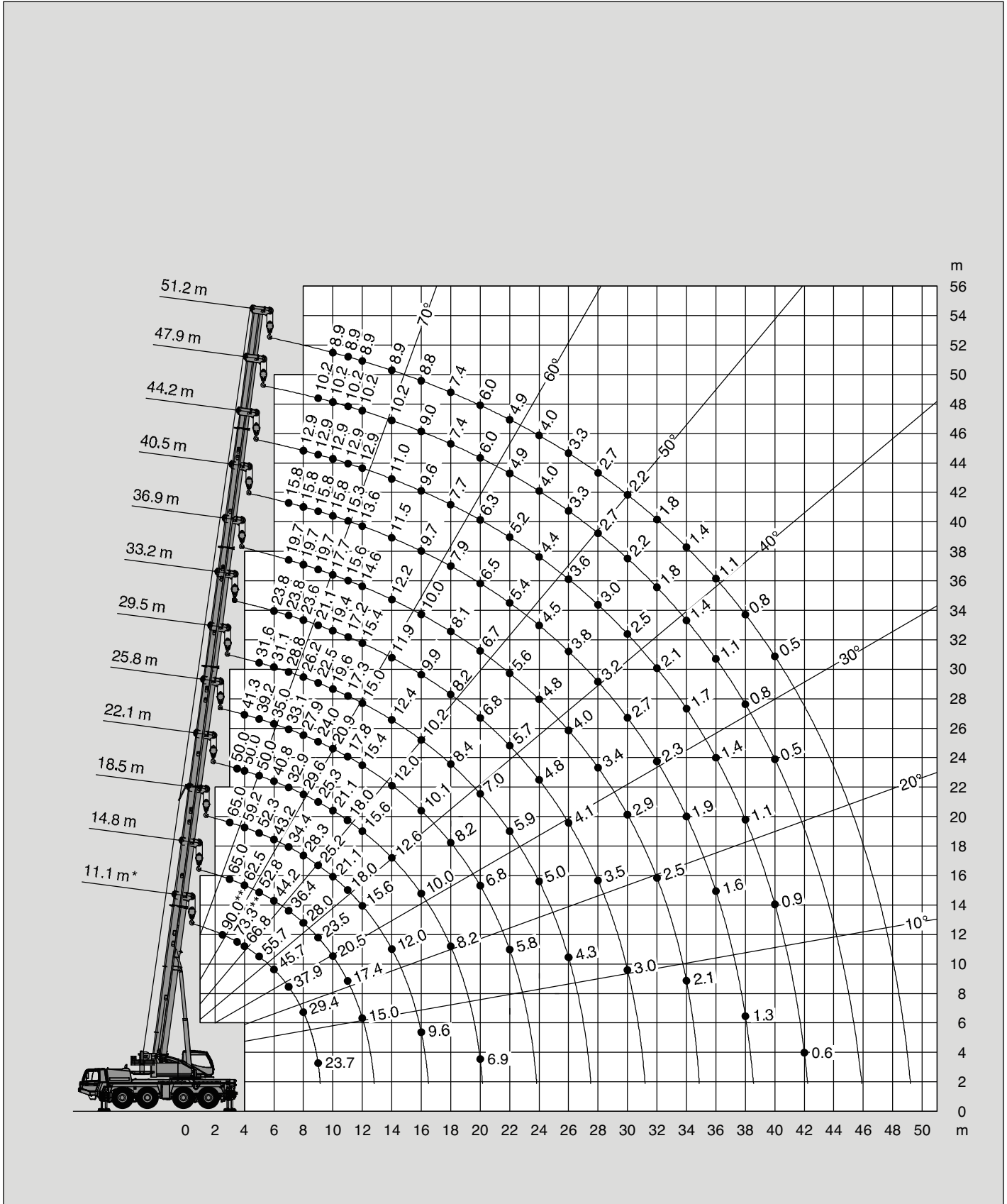

10.6t

DIN/ISO/EN



Tragfähigkeiten
Lifting capacities
Capacités de levage
Capacidades de elevación

													
 m	11.1 m*	11.1 m	14.8 m	18.5 m	22.1 m	25.8 m	29.5 m	33.2 m	36.9 m	40.5 m	44.2 m	47.9 m	51.2 m
2.5	90.0**												
3.0	81.1**	76.0**	65.0	65.0									
3.5	73.3**	69.0	65.0	63.2	50.0								
4.0	66.8	63.0	62.5	59.2	50.0	41.3							
4.5	61.3	57.8	57.3	55.6	50.0	40.9							
5.0	55.7	53.3	52.8	52.3	50.0	39.2	31.6						
6.0	45.7	44.8	44.2	43.2	40.8	35.0	31.1	23.8					
7.0	37.9	37.5	36.4	34.4	32.9	33.1	28.8	23.8	19.7	15.8			
8.0	29.4	29.0	28.0	28.3	29.6	27.9	26.2	23.6	19.7	15.8	12.9		
9.0	23.7	23.4	23.5	25.2	25.3	24.0	22.5	21.1	19.7	15.8	12.9	10.2	
10.0			20.5	21.1	21.1	20.9	19.6	19.4	17.7	15.8	12.9	10.2	8.9
11.0			17.4	18.0	18.0	17.8	17.3	17.2	15.6	15.3	12.9	10.2	8.9
12.0			15.0	15.6	15.6	15.4	15.0	15.4	14.6	13.6	12.9	10.2	8.9
14.0				12.0	12.6	12.0	12.4	11.9	12.2	11.5	11.0	10.2	8.9
16.0				9.6	10.0	10.1	10.2	9.9	10.0	9.7	9.6	9.0	8.8
18.0					8.2	8.2	8.4	8.2	8.1	7.9	7.7	7.4	7.4
20.0					6.9	6.8	7.0	6.8	6.7	6.5	6.3	6.0	6.0
22.0						5.8	5.9	5.7	5.6	5.4	5.2	4.9	4.9
24.0							5.0	4.8	4.8	4.5	4.4	4.0	4.0
26.0								4.3	4.1	4.0	3.8	3.6	3.3
28.0									3.5	3.4	3.2	3.0	2.7
30.0									3.0	2.9	2.7	2.5	2.2
32.0										2.5	2.3	2.1	1.8
34.0										2.1	1.9	1.7	1.4
36.0											1.6	1.4	1.1
38.0												1.1	0.8
40.0													0.8
42.0													0.5
44.0													
46.0													
48.0													

* Nach hinten / * Over rear / * A l'arrière / * Sobre la parte trasera

** Mit Zusatzhubausrüstung / ** With additional lifting equipment / ** Avec équipement supplémentaire / ** Con equipo adicional

Hubhöhen
Lifting heights
Hauteurs de levage
Alturas de elevación

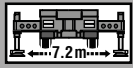
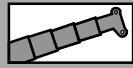



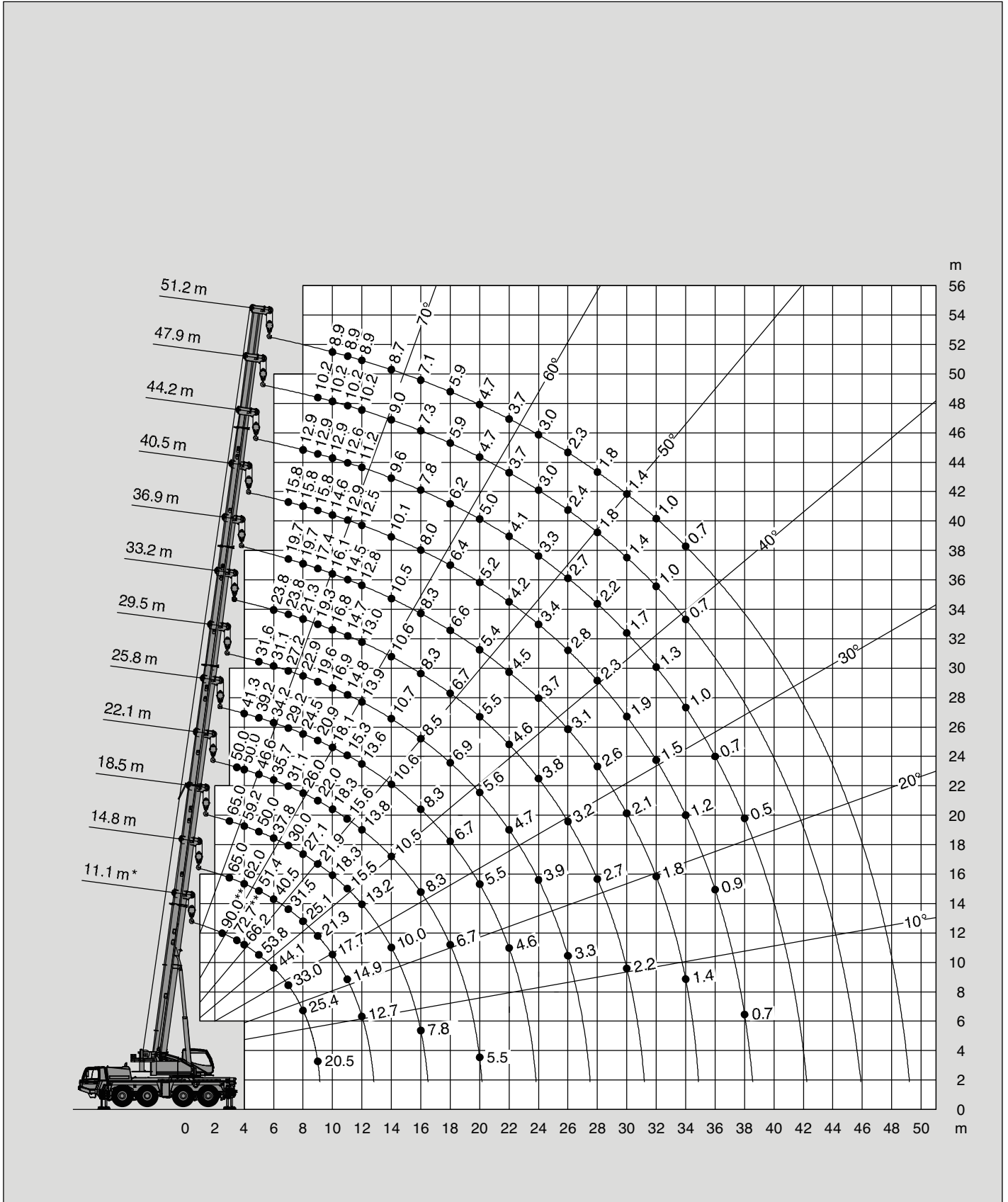

6.5t

DIN/ISO/EN

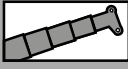

Tragfähigkeiten
Lifting capacities
Capacités de levage
Capacidades de elevación

   DIN/ISO/EN													
 m	11.1 m*	11.1 m	14.8 m	18.5 m	22.1 m	25.8 m	29.5 m	33.2 m	36.9 m	40.5 m	44.2 m	47.9 m	51.2 m
2.5	90.0**												
3.0	80.4**	75.6**	65.0	65.0									
3.5	72.7**	68.5	65.0	63.2	50.0								
4.0	66.2	62.4	62.0	59.2	50.0	41.3							
4.5	60.3	57.2	56.7	55.6	50.0	40.9							
5.0	53.8	52.0	51.4	50.0	46.6	39.2	31.6						
6.0	44.1	43.5	40.5	37.8	35.7	34.2	31.1	23.8					
7.0	33.0	32.6	31.5	30.0	31.1	29.2	27.2	23.8	19.7	15.8			
8.0	25.4	25.1	25.1	27.1	26.0	24.5	22.9	21.3	19.7	15.8	12.9		
9.0	20.5	20.1	21.3	21.9	22.0	20.9	19.6	19.3	17.4	15.8	12.9	10.2	
10.0			17.7	18.3	18.3	18.1	16.9	16.8	16.1	14.6	12.9	10.2	8.9
11.0			14.9	15.5	15.6	15.3	14.8	14.7	14.5	12.9	12.6	10.2	8.9
12.0			12.7	13.2	13.8	13.6	13.9	13.0	12.8	12.5	11.2	10.2	8.9
14.0				10.0	10.5	10.6	10.7	10.6	10.5	10.1	9.6	9.0	8.7
16.0				7.8	8.3	8.3	8.5	8.3	8.3	8.0	7.8	7.3	7.1
18.0					6.7	6.7	6.9	6.7	6.6	6.4	6.2	5.9	5.9
20.0					5.5	5.5	5.6	5.5	5.4	5.2	5.0	4.7	4.7
22.0						4.6	4.7	4.6	4.5	4.2	4.1	3.7	3.7
24.0							3.9	3.8	3.7	3.4	3.3	3.0	3.0
26.0								3.3	3.2	3.1	2.8	2.4	2.3
28.0									2.7	2.6	2.3	1.8	1.8
30.0									2.2	2.1	1.9	1.4	1.4
32.0										1.8	1.5	1.0	1.0
34.0										1.4	1.2	0.7	0.7
36.0											0.9	0.7	
38.0											0.7	0.5	
40.0													
42.0													
44.0													
46.0													
48.0													

* Nach hinten / * Over rear / * A l'arrière / * Sobre la parte trasera

** Mit Zusatzhubausrüstung / ** With additional lifting equipment / ** Avec équipement supplémentaire / ** Con equipo adicional

Hubhöhen
Lifting heights
Hauteurs de levage
Alturas de elevación

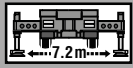
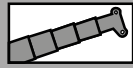



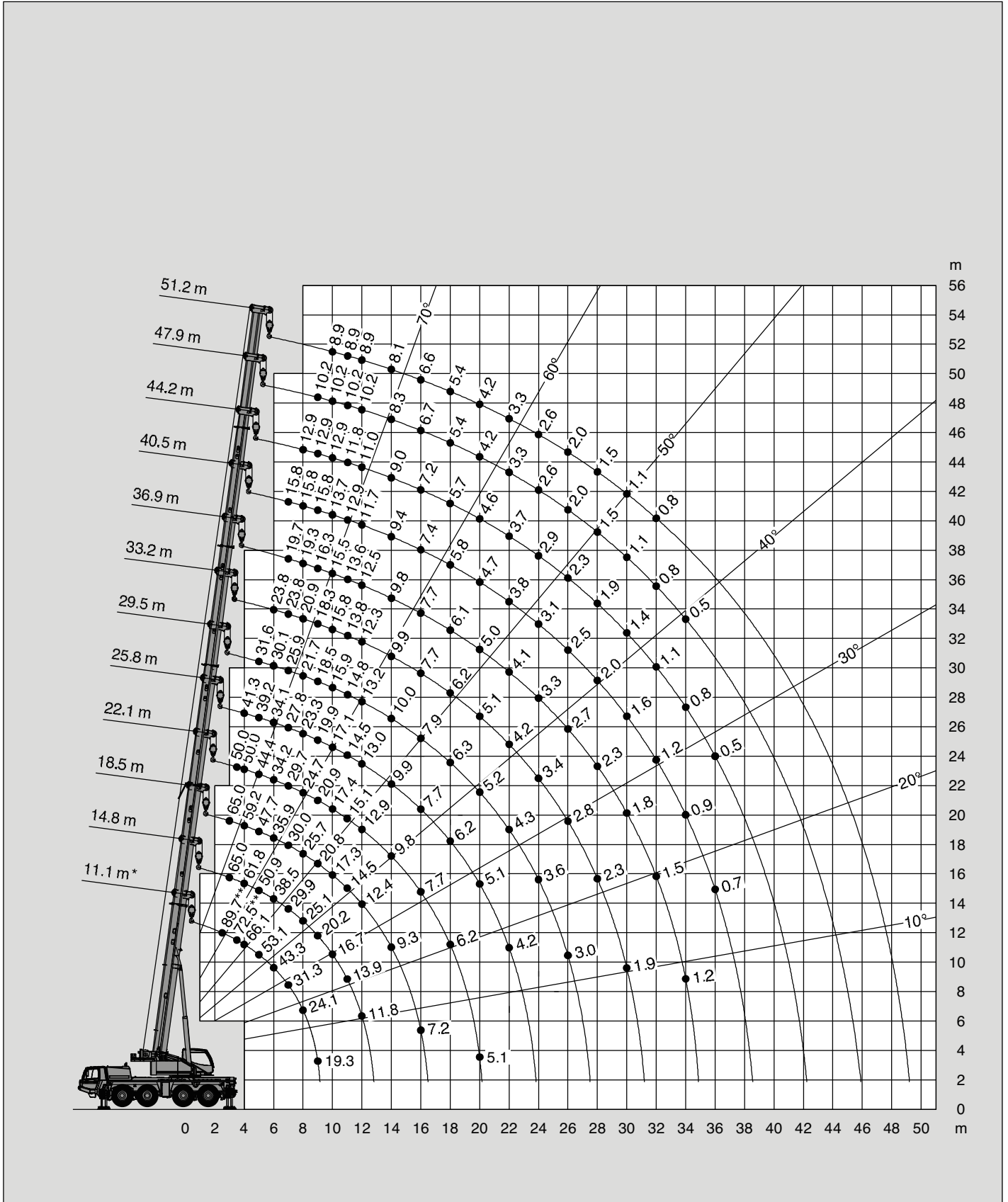

5.5t

DIN/ISO/EN

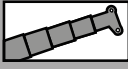

Tragfähigkeiten
Lifting capacities
Capacités de levage
Capacidades de elevación

   DIN/ISO/EN													
 m	11.1 m*	11.1 m	14.8 m	18.5 m	22.1 m	25.8 m	29.5 m	33.2 m	36.9 m	40.5 m	44.2 m	47.9 m	51.2 m
2.5	89.7**												
3.0	80.3**	75.4**	65.0	65.0									
3.5	72.5**	68.3	65.0	63.2	50.0								
4.0	66.1	62.3	61.8	59.2	50.0	41.3							
4.5	59.5	56.8	56.3	55.1	50.0	40.9							
5.0	53.1	51.5	50.9	47.7	44.4	39.2	31.6						
6.0	43.3	42.8	38.5	35.9	34.2	34.1	30.1	23.8					
7.0	31.3	30.9	29.9	30.0	29.7	27.8	25.9	23.8	19.7	15.8			
8.0	24.1	23.8	25.1	25.7	24.7	23.3	21.7	20.9	19.3	15.8	12.9		
9.0	19.3	19.0	20.2	20.8	20.9	19.9	18.5	18.3	16.3	15.8	12.9	10.2	
10.0			16.7	17.3	17.4	17.1	15.9	15.8	15.5	13.7	12.9	10.2	8.9
11.0			13.9	14.5	15.1	14.5	14.8	13.8	13.6	12.9	11.8	10.2	8.9
12.0			11.8	12.4	12.9	13.0	13.2	12.3	12.5	11.7	11.0	10.2	8.9
14.0				9.3	9.8	9.9	10.0	9.9	9.8	9.4	9.0	8.3	8.1
16.0				7.2	7.7	7.7	7.9	7.7	7.7	7.4	7.2	6.7	6.6
18.0					6.2	6.2	6.3	6.2	6.1	5.8	5.7	5.4	5.4
20.0					5.1	5.1	5.2	5.1	5.0	4.7	4.6	4.2	4.2
22.0						4.2	4.3	4.2	4.1	3.8	3.7	3.3	3.3
24.0							3.6	3.4	3.3	3.1	2.9	2.6	2.6
26.0							3.0	2.8	2.7	2.5	2.3	2.0	2.0
28.0								2.3	2.3	2.0	1.9	1.5	1.5
30.0								1.9	1.8	1.6	1.4	1.1	1.1
32.0									1.5	1.2	1.1	0.8	0.8
34.0									1.2	0.9	0.8	0.5	
36.0										0.7	0.5		
38.0													
40.0													
42.0													
44.0													
46.0													
48.0													

* Nach hinten / * Over rear / * A l'arrière / * Sobre la parte trasera

** Mit Zusatzhubausrüstung / ** With additional lifting equipment / ** Avec équipement supplémentaire / ** Con equipo adicional

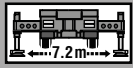
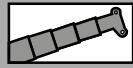

Hubhöhen
Lifting heights
Hauteurs de levage
Alturas de elevación

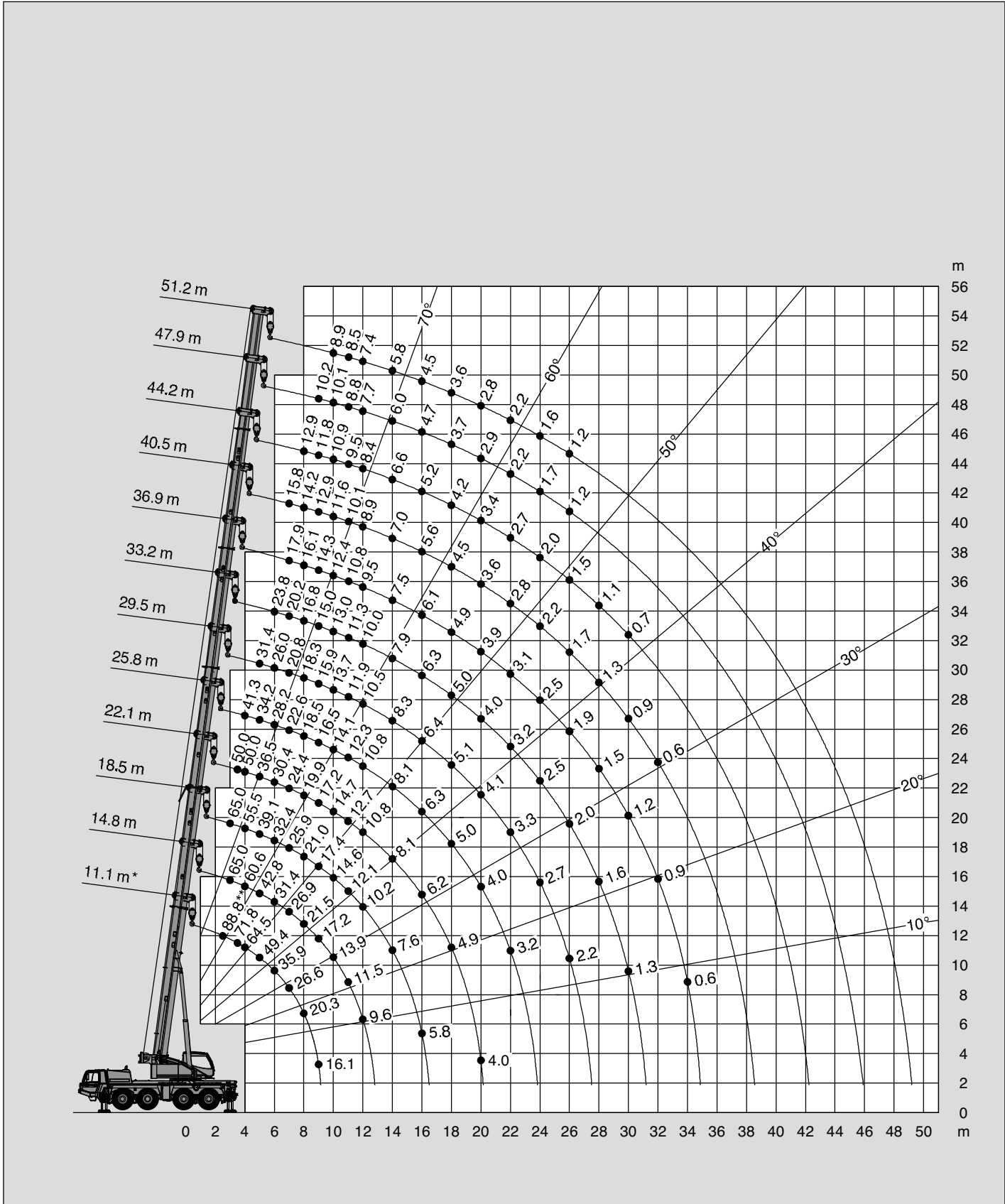

DIN/ISO/EN

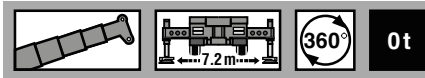

Tragfähigkeiten
Lifting capacities
Capacités de levage
Capacidades de elevación

													DIN/ISO/EN	
 m	11.1 m*	11.1 m	14.8 m	18.5 m	22.1 m	25.8 m	29.5 m	33.2 m	36.9 m	40.5 m	44.2 m	47.9 m	51.2 m	
2.5	88.8**													
3.0	79.4**	74.7**	65.0	65.0										
3.5	71.8	67.5	65.0	63.2	50.0									
4.0	64.5	61.2	60.6	55.5	50.0	41.3								
4.5	56.9	54.9	51.6	46.6	42.9	38.5								
5.0	49.4	49.4	42.8	39.1	36.5	34.2	31.4							
6.0	35.9	35.9	31.4	32.4	30.4	28.2	26.0	23.8						
7.0	26.6	26.5	26.9	25.9	24.4	22.6	20.8	20.2	17.9	15.8				
8.0	20.3	20.2	21.5	21.0	19.9	18.5	18.3	16.8	16.1	14.2	12.9			
9.0	16.1	15.9	17.2	17.4	17.2	16.5	15.9	15.0	14.3	12.9	11.8	10.2		
10.0			13.9	14.6	14.7	14.1	13.7	13.0	12.4	11.6	10.9	10.1	8.9	
11.0			11.5	12.1	12.7	12.3	11.9	11.3	10.8	10.1	9.5	8.8	8.5	
12.0			9.6	10.2	10.8	10.8	10.5	10.0	9.5	8.9	8.4	7.7	7.4	
14.0				7.6	8.1	8.1	8.3	7.9	7.5	7.0	6.6	6.0	5.8	
16.0				5.8	6.2	6.3	6.4	6.3	6.1	5.6	5.2	4.7	4.5	
18.0					4.9	5.0	5.1	5.0	4.9	4.5	4.2	3.7	3.6	
20.0					4.0	4.0	4.1	4.0	3.9	3.6	3.4	2.9	2.8	
22.0						3.2	3.3	3.2	3.1	2.8	2.7	2.2	2.2	
24.0							2.7	2.5	2.5	2.2	2.0	1.7	1.6	
26.0							2.2	2.0	1.9	1.7	1.5	1.2	1.2	
28.0								1.6	1.5	1.3	1.1			
30.0								1.3	1.2	0.9	0.7			
32.0									0.9	0.6				
34.0									0.6					
36.0														
38.0														
40.0														
42.0														
44.0														
46.0														
48.0														

* Nach hinten / * Over rear / * A l'arrière / * Sobre la parte trasera

** Mit Zusatzhubausrüstung / ** With additional lifting equipment / ** Avec équipement supplémentaire / ** Con equipo adicional